

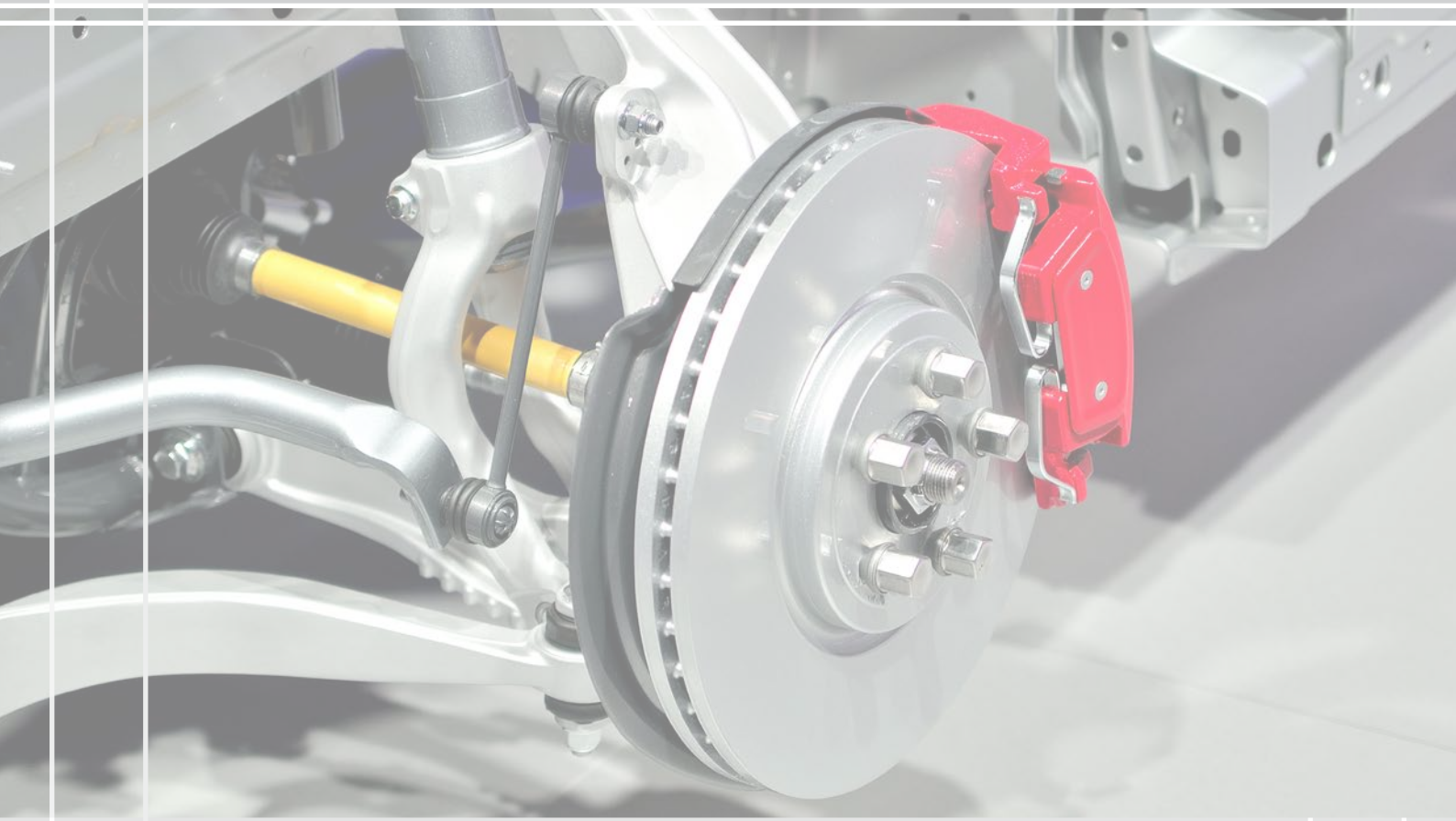



More Precision

capa**NCDT** DTV // Measuring Disc Thickness Variation



- 
- Non-contact measurement of Disc Thickness Variation
 - Dynamic and precise measurements
 - Robust sensor design for long-life operation
 - Suitable for test bench, road test and car repair shops

With the capaNC DT DT, Micro-Epsilon has developed a product range that is specifically used for non-contact detection of Disc Thickness Variation. Disc Thickness Variation (DTV) is the thickness deviation of brake discs. In order to achieve maximum efficiency of the braking system, the disc must have an even thickness. Unevenness, runout or abrasion on the friction surface of the disc cause the brake pads to lose contact with the rotating disc.

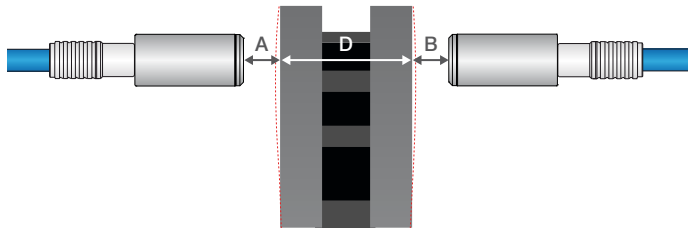

Thickness measurements can be performed in test benches, road tests and in car repair shops using non-contact, capacitive displacement sensors, which detect the thickness of the brake disc from both sides. The thickness is determined by using the difference principle. While the brake disc rotates, the thickness deviation is determined via the circumference of the entire disc. Using several sensors in pairs enables multi-track thickness measurements.

Special DTV software calculates and delivers thickness values over time, providing real-time evaluation of measured results.

Robust multi-channel system
for test benches and road tests page 4 - 5



Case for
mobile DTV measurements page 6 - 7



Robust multi-channel system

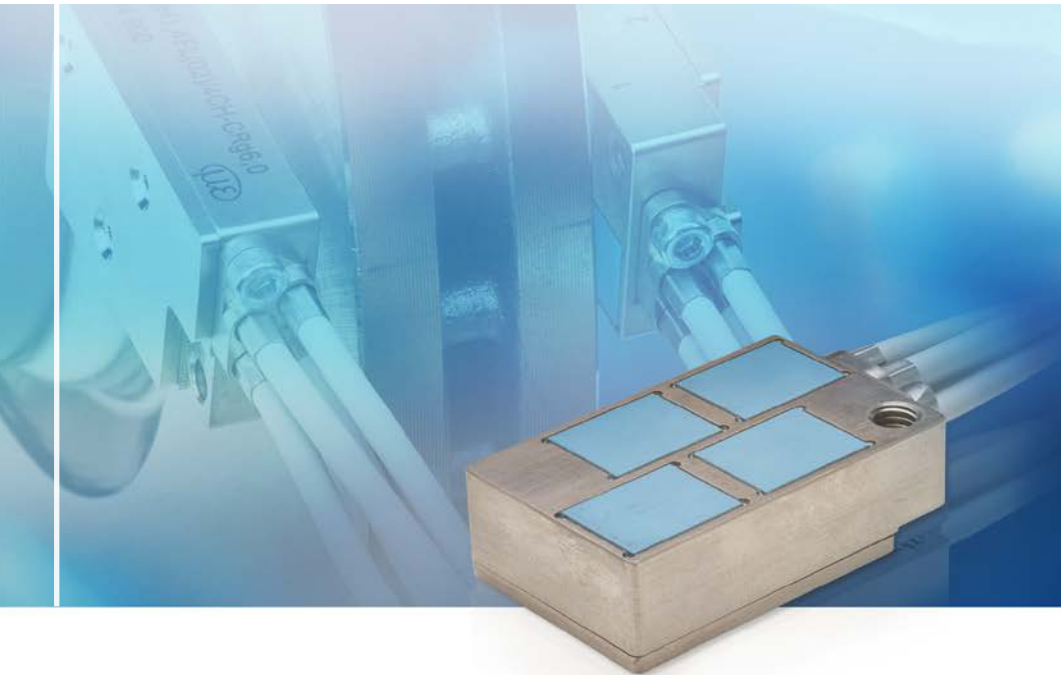

- Robust multi-channel sensor for multi-track measurements
- Modular multi-channel controller
- For dynamic measurements
- Comprehensive software package
- Successful in test benches and road tests

Innovative 4-channel sensor

The CSH1,4FL is a unique multi-track sensor for DTV measurements. In the compact housing, four capacitive sensors operate in standalone mode. This is how four tracks on the brake disc can be detected synchronously. A special ceramic substrate protects the sensors from mechanical and thermal loads, providing high temperature stability, which is extremely important in the case of fluctuating ambient temperatures. In order to enable accurate thickness measurements, the sensors are available as mirror-inverted arrangements that can be mounted on opposite sides of the brake disc while considerably reducing mounting effort.

Capacitive controller for dynamic measurement tasks

Combined with the DT6220 controller, four sensor channels can be processed synchronously. Due to the high bandwidth, dynamic measurements up to 5kHz (-3dB) are possible. Data output is via an analog output or a digital Ethernet/EtherCAT interface. An intuitive web interface enables fast, easy set up and configuration of the sensor and controller.

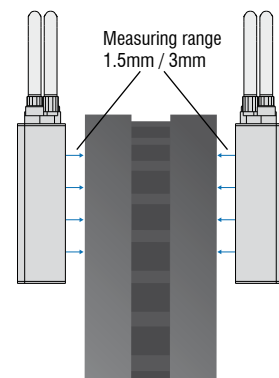

CSH1,4FL/4CH sensors enable robust and high precision multi-track measurements with very little installation effort.



Sensor type	CSH1,4FL/4CH-CRg6,0 capacitive quadruple flat sensor	
Article number	6610158.01 (left), 6610158.02 (right)	
Measuring range	nominal	1.5mm
	extended	3mm
Linearity	nominal	$\leq 0.2\%$ FSO
	static, 10Hz	$0.28\mu\text{m}$
Resolution	dynamic, 8.5kHz	$0.7\mu\text{m}$
	Offset difference of the 4 sensors	$< \pm 50\mu\text{m}$
Temperature stability	100ppm/°C	
Temperature range (storage)	-50°C ... +85°C	
Temperature range (operation)	Sensor	-40°C ... +150°C
	Connection cable	-40 °C... +85°C, (10,000 h @ 100°C)
Permissible humidity ¹⁾	0% ... 95% r.H.	
Mounting	via M5 thread and fitting surface	
Active measuring area	approx. 5 x 8mm	
Minimum size of the opposite face per sensor	approx. 11 x 14mm	
Center distance (sensors)	8mm	
Total detection width	32mm in 4 tracks à 8mm	
Weight incl. cable	approx. 450g	
Cable integrated	Ø3.1mm, 6m length, triaxial (other specifications on request)	
Cable bending radius	static	10mm
	dynamic	25mm

Recommended controller	DT6220 with DL6230	
Bandwidth	5kHz (-3dB)	
Bandwidth (switchable)	5kHz, 20Hz	
Data rate digital output	max. 3.906kSa/s	
Sensitivity deviation	$\leq \pm 0.1\%$ FSO	
Long-term stability	$\leq 0.02\%$ FSO/month	
Temperature range (storage)	-10°C ... +75°C	
Temperature range (operation)	+10°C ... +60°C	
Power supply	24VDC (12...36 VDC)	
Analog output	0...10V (short circuit proof)	
	4...20mA (load max. 500Ohm)	
Digital interface	Ethernet + EtherCAT	
Trigger	TTL, 5V	
No. of channels	max. 4	

FSO = Full Scale Output

¹⁾ non-condensing

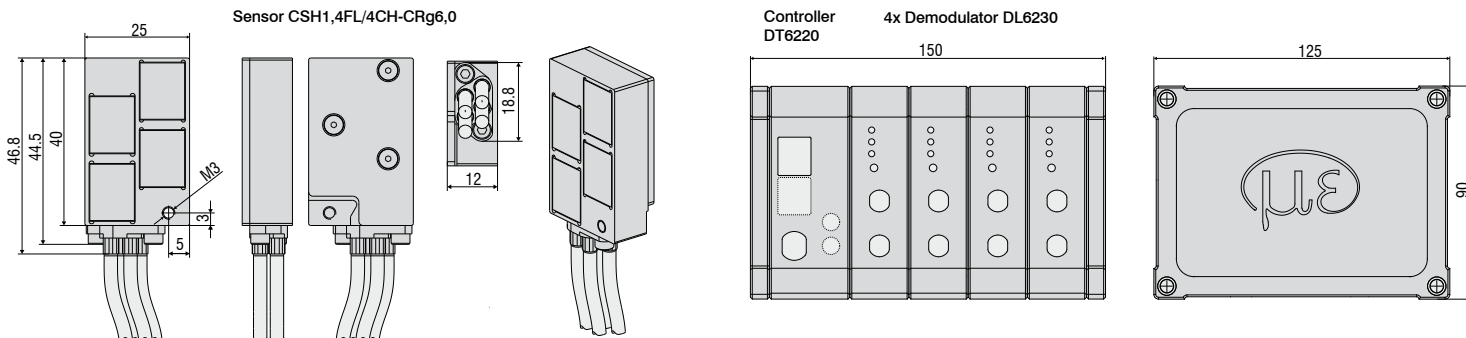

DTV case for mobile use



capaNCDT6229(02)/DTV
dual-channel measurement
system incl. software license

Two capacitive CS1
displacement sensors

Conversion kit with grounding terminals

Software for DTV measurement

Bracket kit for DTV measurement

Two capaNCDT CCg2,0B/90 sensor cables

Case for mobile DTV measurements

The DTV test kit is intended for mobile use, e.g. for quality assurance purposes and warranty claims. The case contains a 2-channel controller incl. software license, two sensors with corresponding cable and a bracket kit. The measuring unit can be set up quickly and DTV evaluations are carried out via PC or notebook.

Capacitive controller for dynamic measurement tasks

Combined with the DT6229(02)/DTV controller, both sensor channels can be processed synchronously. Due to the high bandwidth, dynamic measurements up to 5kHz (-3dB) are possible. Data output is via analog output or an Ethernet interface. In addition, the Ethernet interface enables fast, easy configuration of sensor controller via a web interface.

Comprehensive software

The controller is activated for Disk Thickness Variation Measurement Software from Micro-Epsilon. Intelligent algorithms enable versatile evaluations without having to use an additional encoder. Brake disc holes can be hidden using filters. Future updates are free.



The sensor pair can be adapted to different disc thicknesses using the adjustable bracket kit.

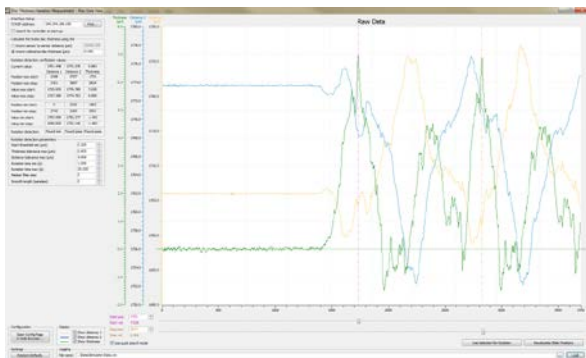

Software for DTV measurement

- Automatic and manual detection of rotation via peak-to-peak evaluation
- Print and memory
- Automatic compensation with perforated brake discs
- Free software updates

Sensor type		CS1
Article number		6610054
Measuring range	nominal	1mm
Linearity	nominal	≤ 0.2% FSO
Resolution	static, 10Hz	0.75nm
	dynamic, 8.5kHz	20nm
Temperature stability		-32nm/°C
Temperature range (storage)		-40°C ... +200°C
Temperature range (operation)		-40°C ... +200°C
Permissible humidity ¹⁾		0% ... 95% r.H.
Mounting		clamping
Active measuring area		Ø5.7
Dimensions		Ø10 × 21mm

Controller		DT6229(02)/DTV
Bandwidth		5kHz (-3dB)
Bandwidth (switchable)		5kHz, 20Hz
Data rate digital output		max. 3.906kSa/s
Sensitivity deviation		≤ ±0.1% FSO
Long-term stability		≤ 0.02 % FSO/month
Temperature range (storage)		-10°C ... +75°C
Temperature range (operation)		+10 °C... +60 °C
Power supply		24VDC (12...36 VDC)
Analog output		0...10V (short circuit proof)
		4...20mA (load max. 500Ohm)
Digital interface		Ethernet
Trigger		TTL, 5V
No. of channels		max. 4

FSO = Full Scale Output

¹⁾ non-condensing



Adjustable bracket kit for DTV measurement

- Incl. mounting bracket for max. 4 CSI sensors (2 CS1 sensors + sensor cable included in delivery)
- Dimensions: approx. 180mm x 170mm
- Conversion kit with grounding terminals

capaNCDT6229(02)/DTV controller incl. software license

- Integrated oscillator for synchronous operation of 2 channels in one housing
- Power supply 12...36 VDC, incl. supply cable PC6200-3/4
- 4-pole socket for signal output

Application examples of brake disc measurements



Temperature measurement of brake discs in racing cars

In order to optimize the braking system of a motorsport vehicle or racing car, the heating of the disc is determined in road tests. Therefore, an infrared temperature sensor is used to detect brake disc temperatures to the highest possible measurement precision on a non-contact basis. Based on this data, the planned load on the braking system is determined during the race.



Distinction of brake discs

When mounting car brake discs, the correct brake disc must be chosen before each stage of production in order to assign it to the respective manufacturer. Laser scanners are used to recognize and classify the brake discs by measuring the gap between the ventilation blades and categorize the respective disc model based on the gap sizes.



Measuring brake disc run-out

The deformation of the red-hot glowing brake disc during the braking process is measured using Blue Laser sensors. High performance interference filters in the sensor ensure that the receiver element is not dazzled by the red-hot glowing brake disc. Due to the large offset distance, these laser sensors can be installed at a safe distance from the brake disc.



Deformation of a brake disc under load

In order to obtain accurate data about the deformation of the brake disc friction ring under load during the braking process, the disc must be tested under extremely environmental conditions using capacitive displacement sensors. Extremely high temperature stability ensures high precision measurements even where strong temperature fluctuations occur.



Topography measurement of brake discs

Brake discs in different materials undergo wear inspection in a test bench. Due to the different surface properties (mat, shiny, rough, smooth), laser triangulation sensors are used to inspect brake disc topography. The laser sensors are guided over the rotating brake disc using a traversing system and inspect it at a measuring rate of up to 50kHz. The laser sensor also measures wear on new, low-wear materials and can even detect extremely fine cracks.



Gap measurement of brake discs

When manufacturing brake discs, different sizes must be strictly adhered to. One critical feature is the gap between the plates of the brake disc, which ensures good ventilation and therefore cooling of the plate. Laser scanners monitor the dimensional accuracy. The scanners detect the gap width while at the same time verifying if the two discs are positioned correctly to one another. A rotating device enables circumferential inspection of the disc.



TESTING **INDONESIA**
Member Of PT Testindo

Contact Us



Jl. Radin Inten II No. 61B Duren Sawit - Jakarta 13440



021-2956-3045 (Hunting) | 021-2956-3046 | 021-2956-3047



0822 5870 6420 (Anto) | 0813 9929 1909 (Fikri)



sales@testingindonesia.com



www.testingindonesia.co.id